



HANSA

Installation and maintenance guide



4-9



10-11



12-19



20-22



22-25

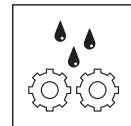

26-29



30

4416 0210

I (ISO 3822)
 EN1112
 50 - 500 kPa
 0.20 l/s (300 kPa w/Controller)
 max. +65°C

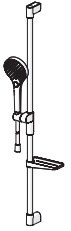
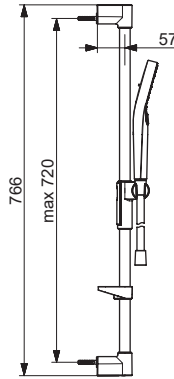
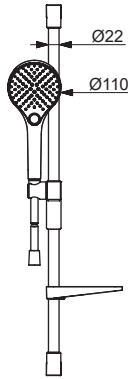

mpi.hansa.com/44160210

4416 0210 0009

I (ISO 3822)
 EN1112
 100 - 1000 kPa
 0.15 l/s (300 kPa w/Controller)
 max. +65°C

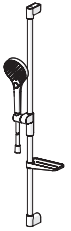
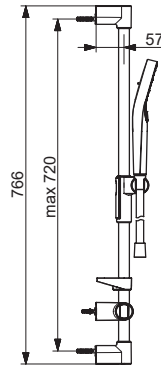
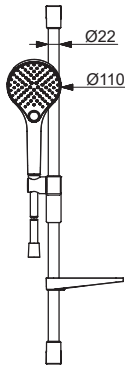

mpi.hansa.com/441602100009

4415 0330

I (ISO 3822)
 EN1112
 50 - 500 kPa
 0.20 l/s (300 kPa w/Controller)
 max. +65°C

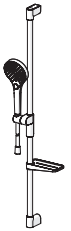
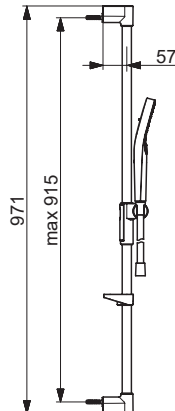
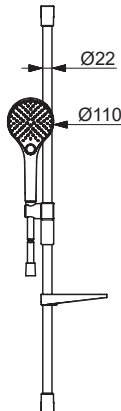

mpi.hansa.com/44150330



A  5x40 x 2

B  21/3x3 x 2

C  8x40 x 2

D  4x12 x 2



1

1

4416 0210

4415 0330

4416 0210 0009

4415 0330 0009

1



L

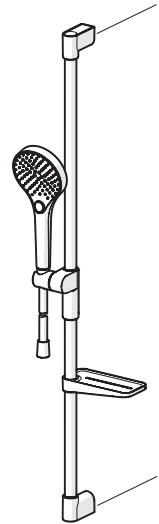

L = max 720

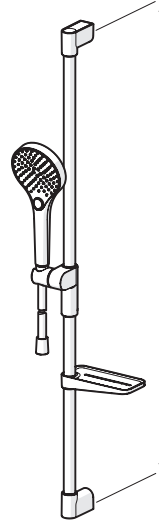

L = max 915

4413 0200

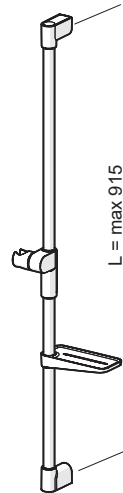

L = max 915

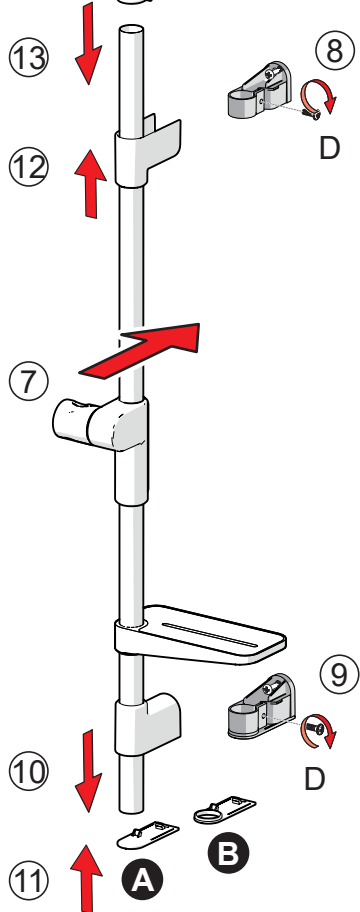
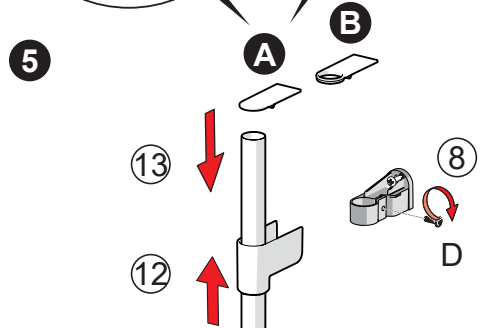
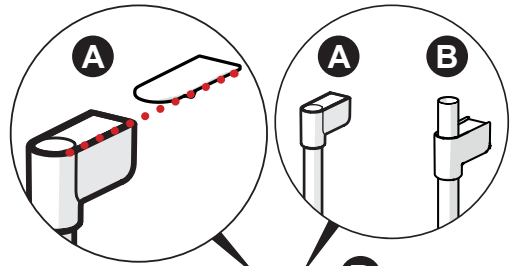
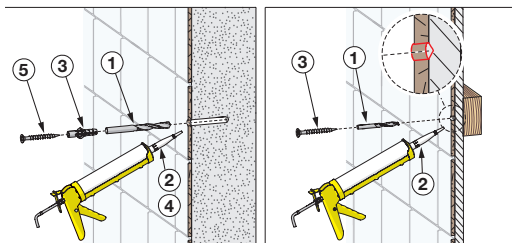
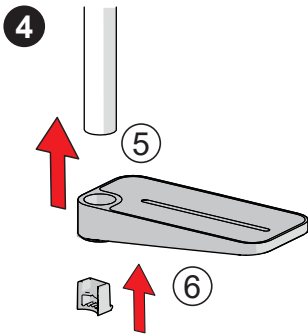
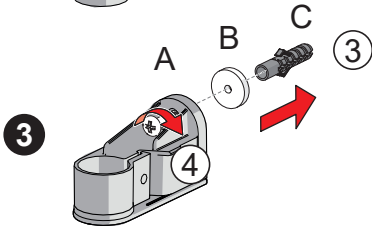
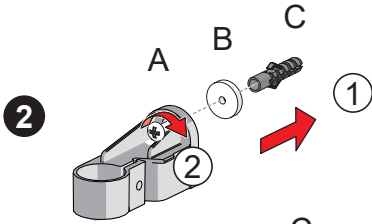
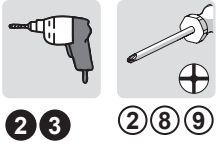



①

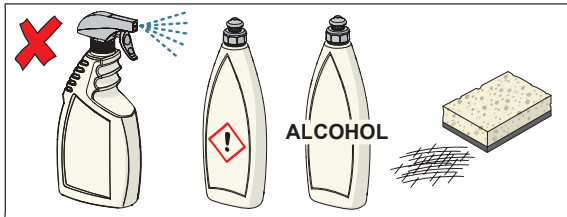
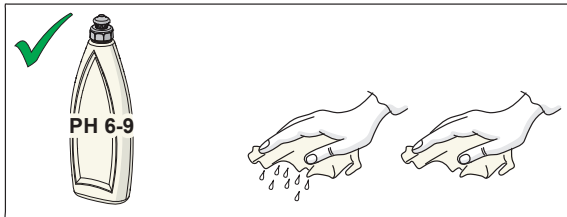
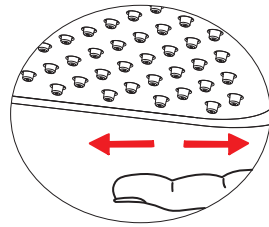
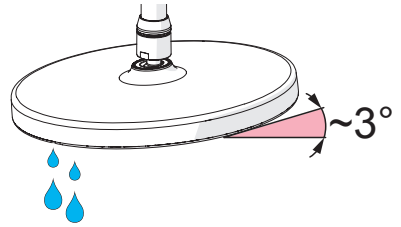
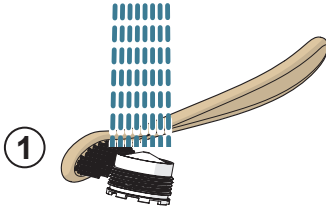

cleaning.hansa.com